

## TAIKAN DOUBLE COLUMN MACHINING CENTER

HIGH-END INTELLIGENT EQUIPMENT  
INTEGRATED SOLUTIONS SERVICE PROVIDER



### SHENZHEN CREATE CENTURY MACHINERY CO.,LTD.

NO.152,Nanpu Road,Xinqiao Street,Bao'an District,Shenzhen City,  
Guangdong Province,China

Tel : +86 755-27255633/733/833

Fax : +86 755-27255933 E-mail : overseas@szccm.com

Http: // www.taikanmachine.com



Follow Wechat



Taikan Sunshine Service



16

Taikan was established in 2005  
16th anniversary

500

Shenzhen's top 500 enterprises ranked 226nd in 2020

100

Shenzhen Bao'an District  
Top 100 enterprises in added value  
Top 100 enterprises in output value  
Top 100 enterprises in paying tax  
Top 100 enterprises in innovation

HIGH-END INTELLIGENT EQUIPMENT  
INTEGRATED SOLUTIONS SERVICE PROVIDER

## COMPANY PROFILE

Based on the machine tool and supporting industry, Taikan will be bigger, stronger and more permanent. In the future, Taikan will develop in the direction of high precision, high efficiency, intelligence and complete sets, and vigorously develop the field of robots and intelligent equipment, products are widely used in 3C, 5G, automation equipment, energy, environmental protection and automobile industry etc. We are committed to promoting the upgrade of people's quality of life with product quality and bringing efficient, green and innovative processing applications and service experience to the world industry.

### Academician (Expert) workstation

The first academician expert workstation in Shenzhen

### Engineering lab

With an area of 1,300 square meters and a total investment up to 30 million yuan, it is equipped with material analysis room, functional component testing room, precision measurement room, comprehensive laboratory, vibration testing room, mechanical performance testing room and EMC testing room.

### Innovation base

Shenzhen Headquarters Innovation Direction: Intelligent Machine Tools, Automation Solutions  
Suzhou Innovation Direction: Parts Machine, Mold Machine, Double Column Machine、CNC lathe

### Qualification honor

- |  |  |
|--|--|
| National high-tech enterprises   | Shenzhen Mayor Quality Award                                   |
| Famous brand in Guangdong province.  | Top 100 quality enterprises in Shenzhen                        |
| Top 500 manufacturers in Guangdong province                                    | 2nd prize of science and technology progress award in Shenzhen |
| Cultivating enterprises of strategic emerging industries in Guangdong province | ISO9001: 2008 Quality Management System Certification          |
| Abide by the contract and credit enterprises in Guangdong province             | ISO14000 Environmental Management System Certification         |
| Famous brand in Shenzhen   |  |



Double column machining center series

# G-V DOUBLE COLUMN MACHINING CENTER SERIES

Good rigidity, high precision and high efficiency

ADVANTAGE

- ▶ G-V portal double column machining center includes series models with worktable widths of 1000mm and 1250mm. The integrated design of the column and beam has good rigidity, high machining accuracy and good stability;
- ▶ The three-axis support adopts roller linear guide, which has fast dynamic response speed, high precision and no creep;
- ▶ The three-axis feed is driven by the direct connection of the motor and the high-precision ball screw. The two ends of the screw are fixed with a pre-stretched structure, and the transmission accuracy is high;
- ▶ The main shaft is equipped with a belt-driven BT50-6000rpm main shaft as standard, and can be equipped with gear heads and electric spindles to meet different processing needs;
- ▶ Z-axis is equipped with nitrogen balance device, with good load characteristics;
- ▶ The machine tool adopts double screw row and front chain plate chip conveyor;
- ▶ The guide rails and lead screws of the machine tool adopt a timing and quantitative lubrication system, and realize fully automatic centralized lubrication through the control of the electrical system;
- ▶ The machine is equipped with FANUC Oi-MF (5) CNC system; FANUC Oi-MF (1) and SIEMENS 828D are optional;
- ▶ This series of machine tools is mainly suitable for high-speed and high-precision machining of parts in industries such as automobiles, laser equipment, automation equipment, energy, rail transit, and molds;



Working ability - Processing data

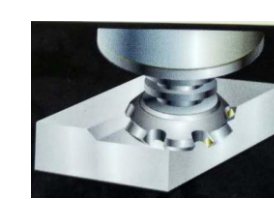

Face milling cutter	φ100mm
Material	S136 die steel
Speed	400rpm
Feed rate	400mm/min
Milling width	80mm
Milling depth	8.5/10/6(fullcut)mm

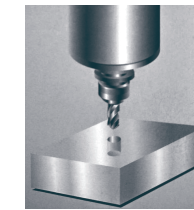

Drill head	φ50mm
Material	S136 die steel
Speed	800rpm
Feed rate	60mm/min
Milling depth	90mm

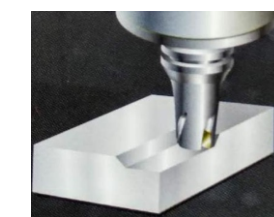

Corn milling cutter	Φ80mm/4 gears
Material	S136 die steel
Speed	600rpm
Feed rate	350mm/min
Milling width	7mm
Milling depth	40mm

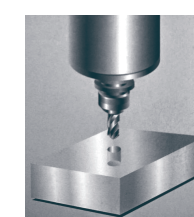

Wire cone	M3	M33
Process material	S136 die steel	
Speed	500rpm	100rpm
Feed	350mm/min	
Depth	10mm	30mm

G-V small double column belt drive power diagram (BiIP30/8000-B)

Power (kW)

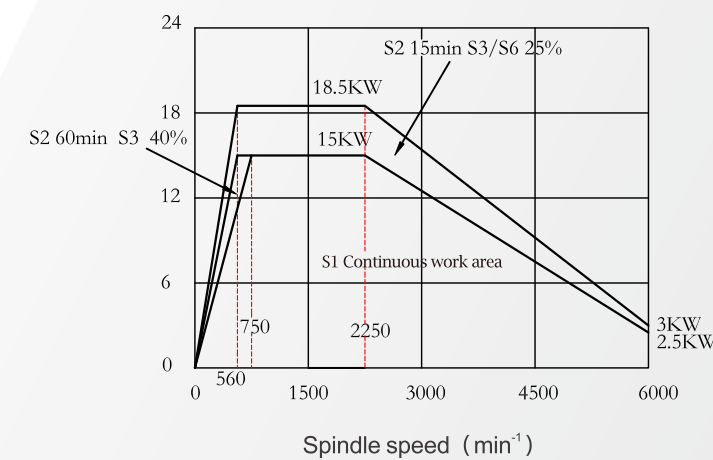

Torque(Nm)

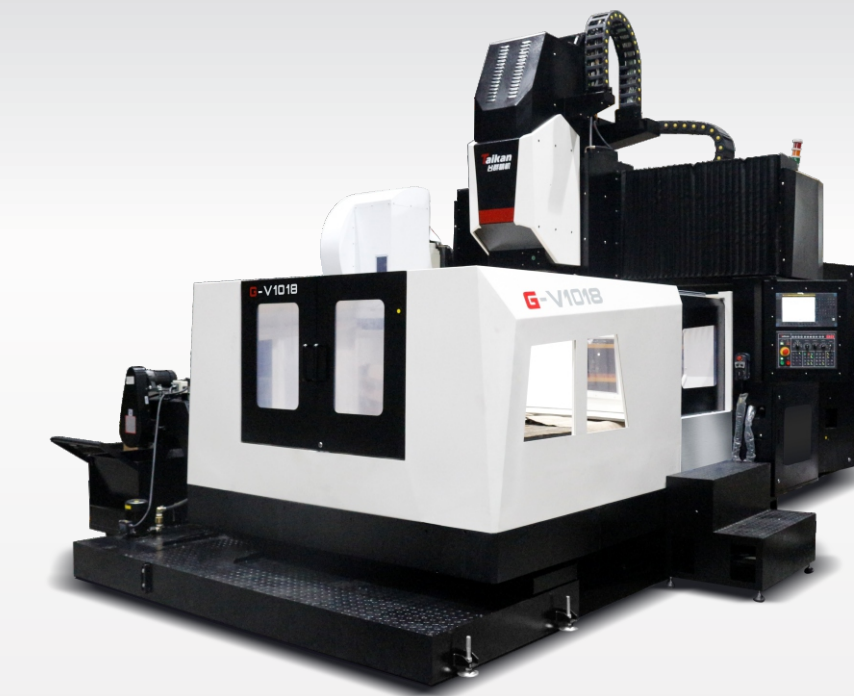
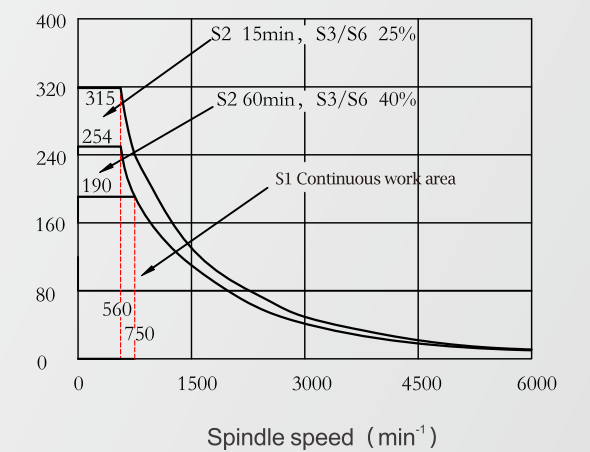

G-V series machine tool model description

Model	G	-	V	**	**	*
Model description	Double column machine	-	Linear rail	Worktable width ×100mm	Worktable length ×100mm	A: Belt drive spindle; B: Spindle with reducer; C: Motorized spindle; Z: Spindle with reducer with automatic right-angle milling head

G-V Gantry type machine center series main parameter

Item		Unit	G-V1018 A <sup>1</sup> /B <sup>2</sup> /C <sup>3</sup>	G-V1220/1225/1230 A <sup>1</sup> /B <sup>2</sup> /C <sup>3</sup>
Range of Processing	Worktable Travel(X axis)	mm	1800	2150/2650/3200
	Saddle Travel(Y axis)	mm	1100+100 (Tool change travel)	1500+25 (Tool change travel)
	Ram Travel(Z axis)	mm	800	800
	Distance From Spindle End to Working table	mm	100~900	100~900
	Available gantry width	mm	1200	1600
Worktable	Table size	mm	1800 × 1000	2000 × 1250/2500 × 1250/3000 × 1250
	Max load	kg	3000	4000/5000/6000
	Width of T-slot	mm	22	22
Spindle	Spindle taper hole	/	A,B:BT50; C:Standard BBT40, Opt HSK -63A	A,B:BT50; C:Standard BBT40, Opt HSK -63A
	Spindle motor power	kw	A,B:15/18.5; C:11/18.5	A,B:15/18.5; C:11/18.5
	Speed range	r/min	A:6000(Φ210 Belt spindle); B:6000(All-g geared drive); C:Standard 15000, Opt 18000(Electric spindle);	A:6000(Φ210 Belt spindle); B:6000(All-g geared drive); C:Standard 15000, Opt 18000(Electric spindle);
	Output torque	N.m	A:191/315; B:286/560; C:45.7/125	A:191/315; B:286/560; C:45.7/125
Drive	Motor power	kw	3.0/3.0/3.0 (Torque 36N.m)	
Tool	Tool magazine capacity	T	24	
	Maximum tool diameter	mm/mm/kg	Φ110/350/18	
	Maximum tool diameter	mm	Φ200	
Speed	Speed of cutting feed	mm/min	1000/1000/1000	
	Rapid Speed of X/Y/Z axis	mm/min	2000/2000/1600	
Precision of Machine Tool	Positioning accuracy (X/Y/Z). (full itinerary)	Raster-free	0.02/0.015/0.015	0.02(0.02/0.025)/0.015/0.015
		Raster	0.015/0.012/0.012	0.015(0.018)/0.012/0.012
	Repetitive positioning accuracy (X/Y/Z). (full itinerary)	Raster-free	0.01/0.008/0.008	0.01(0.011/0.015)/0.008/0.008
		Raster	0.008/0.007/0.007	0.008(0.011)/0.007/0.007
Others	Z axis counterweight		Nitrogen balance	
	CNC System		FANUC Oi-MF(5)[FANUC Oi-MF(1)]; MITSUBISHI M80; SIEMENS 828D	
	Total weight of machine Tool	KVA	40	
	Machine size (length*width*height)	mm	4500/4250/3900	5000(6000/7500)/4500/4000
	Mainframe weight(About)	kg	13500	14500/16000/18000

Gantry machine center

**G-V THREE-TRACK DOUBLE COLUMN MACHINING CENTER**  
**G-R SQUARE RAM HARD RAIL DOUBLE COLUMN MACHINING CENTER**

This series of double column machining tools includes models with a worktable width  $\geq 1500$ mm; among them, the three-axis support surface of the GV series adopts heavy-duty roller linear guides, which are easy to maintain in the later period, have low friction resistance, fast response of moving parts, and no low speed and no crawling, with excellent dynamic and static performance, is especially suitable for the processing of complex parts requiring high load, high rigidity and high precision equipment. The G-R series machine tool adopts the combination configuration of heavy-duty roller linear guide and sliding guide. On the basis of retaining the high-speed and high-precision linear guide configuration of the X and Y axes, it is equipped with a Z-axis ram that is fully enclosed and surrounded by hard rails on all sides. The hard track surface has been widened and lengthened to upgrade the design, so that the heavy cutting ability of the machine tool has been significantly improved; the combination of "two lines and one hard" can not only meet the strong cutting processing of parts under various working conditions, but also has stable performance and good accuracy retention.



ADVANTAGE

- ▶ The G-V series has a three-track structure with fast dynamic response, high precision and no creep;
- ▶ The G-R series "two-wire-hard" support configuration has strong load-bearing capacity and improves the powerful cutting ability of the machine tool.
- ▶ Configurable belt drive, gear head, electric spindle, automatic right-angle milling head;
- ▶ Fixed beam double column machining center with fixed column, fixed beam, and movable table;
- ▶ Suitable for high-speed and high-precision processing;
- ▶ Mainly suitable for parts processing in industries such as automobiles, energy, construction machinery, automation equipment, and molds;
- ▶ The appearance is beautiful and generous, and the operation is convenient.



Note:

1. A is belt transmission spindle
2. B is all-g geared transmission spindle
3. C is electric transmission spindle



### x-axis structure features

- ▶ The bed and worktable are made of high-strength Meehanite cast iron material, which has good shock absorption and shock absorption performance, high strength, and good parts accuracy retention;
- ▶ X axis  $\leq 3200$ : The motor is reduced by the belt to increase the transmission torque, which can reduce the load inertia, and has better drive performance, simple and economical maintenance;
- ▶ X-axis  $\geq 4200$ : The motor's German Sterberg low-magnification reducer reduces the speed, increases the transmission torque, and cooperates with the larger lead screw to achieve high driving speed, stable performance and high precision;
- ▶ The two ends of the screw are fixed with a pre-tensioned structure, which can eliminate the loss of precision caused by thermal elongation;
- ▶ The worktable is supported by multiple sliding blocks to ensure stable and reliable load-bearing performance and good accuracy retention.

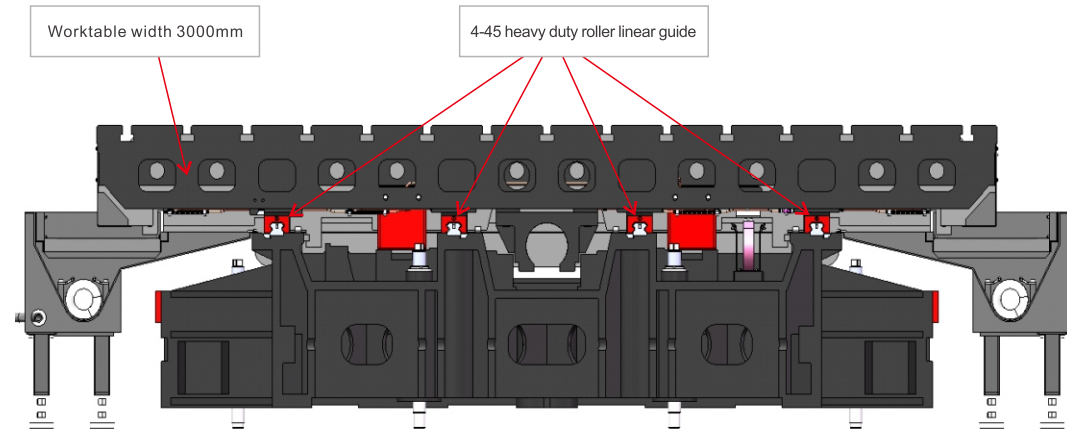
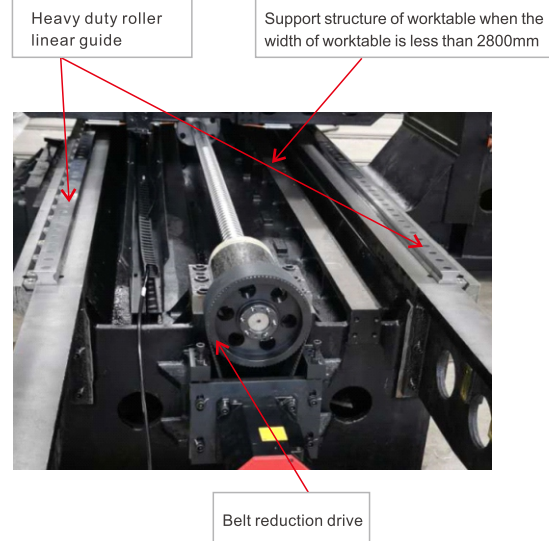

### Spindle motory-axis structure features

The cross beam is designed with rectangular large section arch structure. Through simulation analysis, the best section height width ratio is configured, which greatly improves the bending and torsion resistance. Both ends of the screw rod are used to fix the stretching structure 2-55 heavy duty roller linear guide. When shaft stroke  $\geq 3700$  mm, Debo low double gap reducer drive of the long-span cross beam structure, and ensures the accuracy and stability of the machine

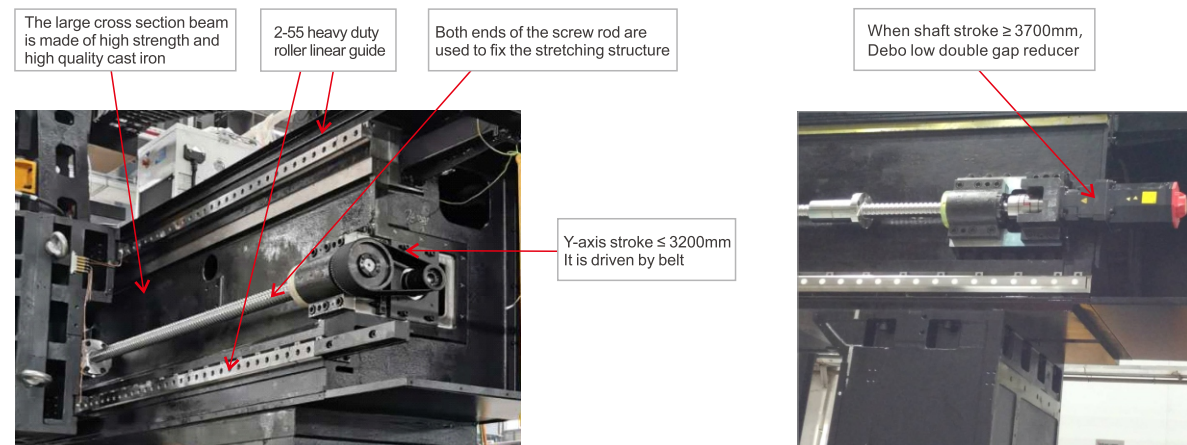

### Introduction to Z-axis structure characteristics

- ▶ Slide saddles and square rams are made of high-strength and high-quality cast iron materials;
- ▶ GV series ram adopts four linear guide rails and semi-enclosed support arrangement. The cross section of the ram is 420x420mm. The structure not only has high support strength, but also has small friction resistance, small difference between static and dynamic friction, low speed no crawling, and high speed vibration. Fast response speed, excellent dynamic and static performance, low maintenance difficulty and long service life;
- ▶ G-R series ram adopts sliding guide rail full-enclosed support arrangement, the cross section of the ram is 400x400mm, and the heavy cutting performance is excellent, which can meet the needs of users;
- ▶ Square ram stroke 1000 mm standard, 1250 mm stroke optional;
- ▶ The transmission system uses a servo motor to directly drive the ball screw pair, and the two sides of the ram are supplemented by a double-cylinder balance system to ensure stable Z-direction feed commutation and fast dynamic response;
- ▶ A variety of spindle drive systems are available.

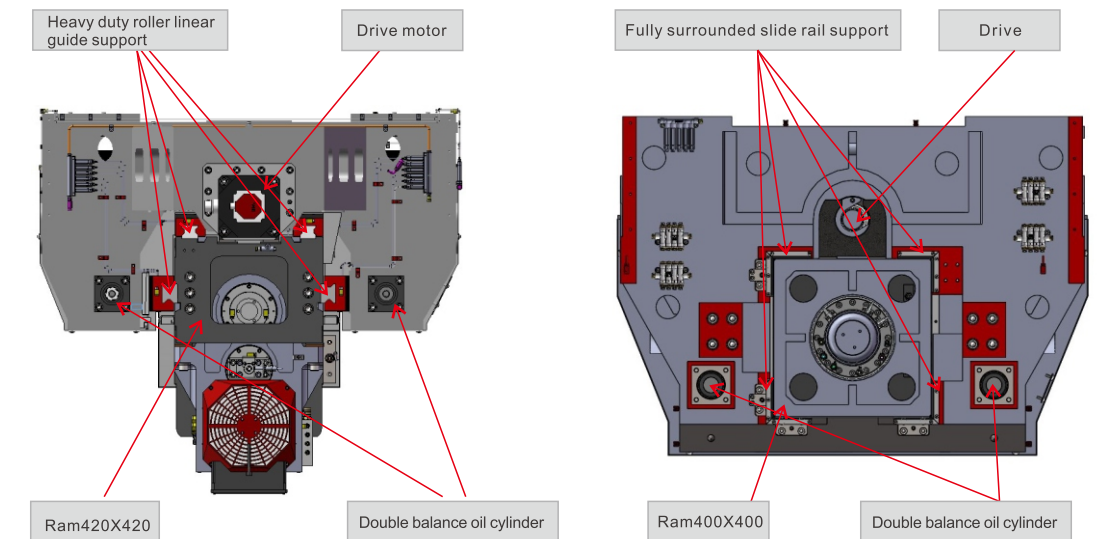

### Other structure features

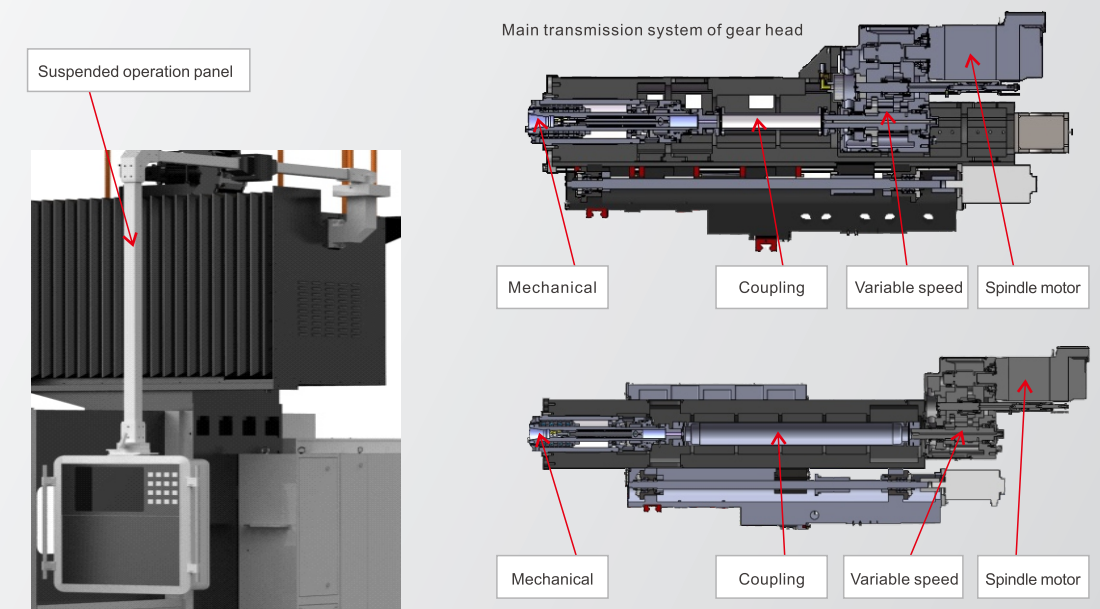

The gearbox and the main motor are far away from the spindle, so that the accuracy problem caused by heating is minimized. At the same time, to ensure that the ram in the effective range of travel, the gearbox and the workpiece do not interfere, so that the coupling as short as possible, so as to improve the rigidity of the main transmission system.



### Gear variable speed structure

- ▶ All imported gear transmission; ▶ High and low gears, automatic shift;
- ▶ Speed ratio: 1:5.64; ▶ Stepless speed regulation within each speed;
- ▶ Integrated gear box with high precision;

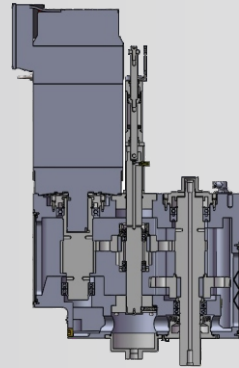

### Timing and quantitative lubrication system

- ▶ Lubrication system: The guide rail and screw of the whole machine adopt fixed-time quantitative grease lubrication system;
- ▶ Grease lubrication is easy to store, long oil supply interval, small usage, green environmental protection;
- ▶ G-R double column series models add a set of automatic thin oil lubrication system to meet the lubrication requirements of sliding guide surface.

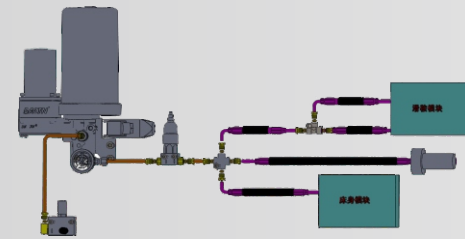

### Motorized spindle

- ▶ Motorized spindle: Strong heavy cutting BT50- 10000r/min motorized spindle, bringing customers the perfect processing
- ▶ Experience of large torque, high speed and low vibration;
- ▶ Spindle loose knife: hydraulic knife, stable and reliable every time, no broaching phenomenon; standard oil cooler to cool the spindle, improve the service life of the bearing, reduce the impact of spindle thermal deformation on machining accuracy.

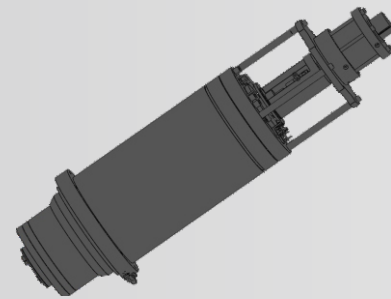

### Mechanical direct spindle

- ▶ Spindle: The high-speed spindle BT50- 6000rpm, the front end of the spindle adopts labyrinth design, and the spindle has the function of air curtain protection to prevent cutting fluid from entering the spindle bearing. The sealing of the back end cover of the spindle is reliable, which can completely prevent the external liquid from entering the spindle bearing, thus preventing fatal injury to the spindle;
- ▶ Spindle loosening knife: Hydraulic knife, stable and reliable every time, no broaching phenomenon;
- ▶ Standard built-in spindle cooling system, no liquid leakage, can greatly improve the service life of the bearing and reduce the impact of spindle thermal deformation on processing

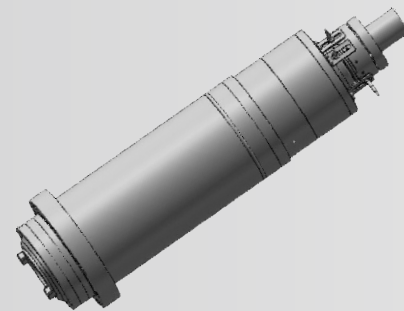

### Transmission output power torque diagram

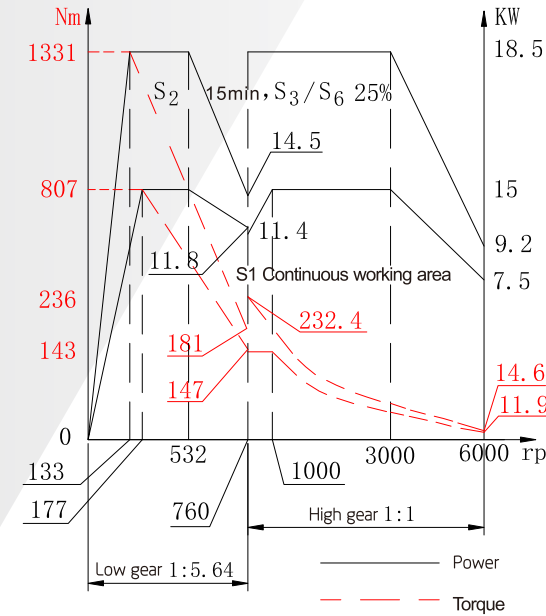

β i1P 30/8000-B

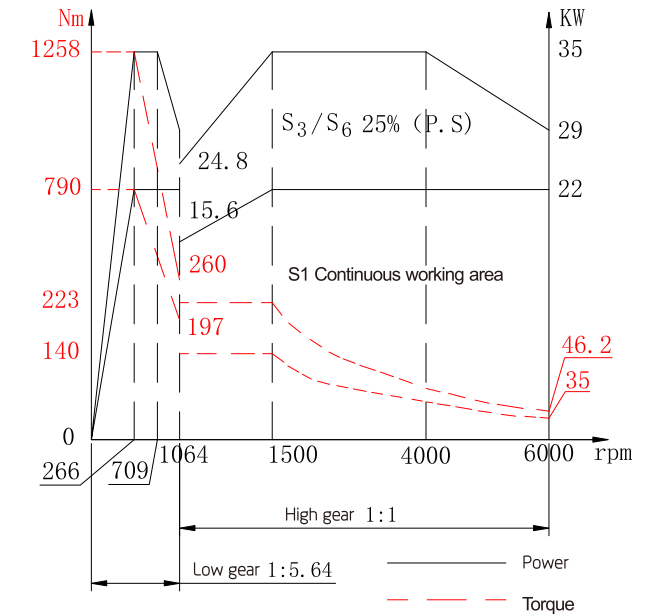

α i1 22/8000-B

### Introduction to the performance of tool magazine parameters

Tool holder specification	BT50
Tool capacity	24T
Tool weight	15kg
Tool length	350mm
Maximum tool diameter (full / adjacent empty)	Φ100/Φ200mm



### Introduction of machine tool chip removal system

- ▶ There is a set of spiral chip ejector on both sides of the worktable;
- ▶ The end of the equipment is equipped with lifting chain chip ejector;
- ▶ The lifting oblique angle of the chip ejector is 45 degrees, the chain plate is widened and there is a sawtooth scraper, which improves the chip removal capacity;
- ▶ The screw diameter of the screw on both sides is 120mm, the square steel section is large, and the chip removal capacity is strong;
- ▶ Optional and equipped with chip transport trolley.

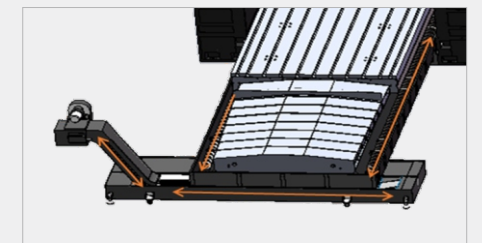



Parameters of motorized spindles for G-V and G-R series

Item	Unit	Standard distributionspindle	Selection of power distribution spindle	
Motorized spindle power: rated / maximum	KW	26/45	15/26	22/37
Motorized spindle output torque: rated / maximum	Nm	305/623	45.7/125	159/326
Speed range	rpm	80 ~ 10000 (BT50)	100 ~ 15000 (BBT40)	100 ~ 12000 (HSK100A)

Motorized spindle power、torque diagram (10000rpm、26/45KW)

Low speed winding

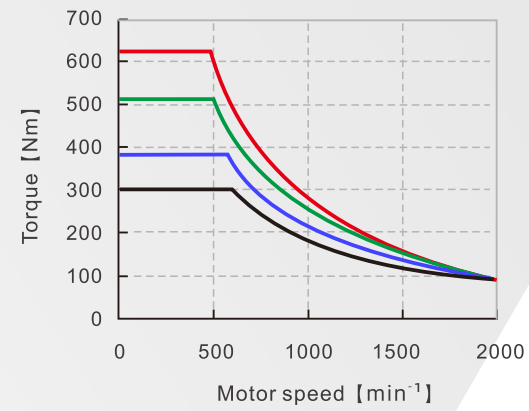
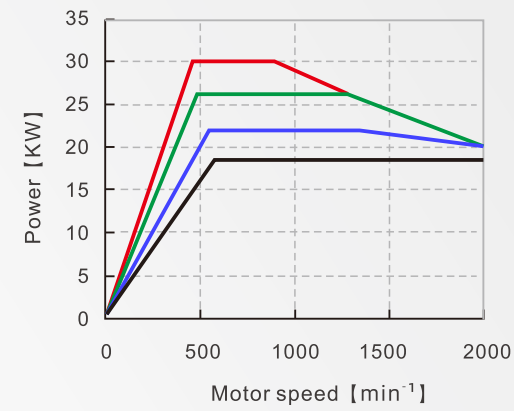

High speed winding

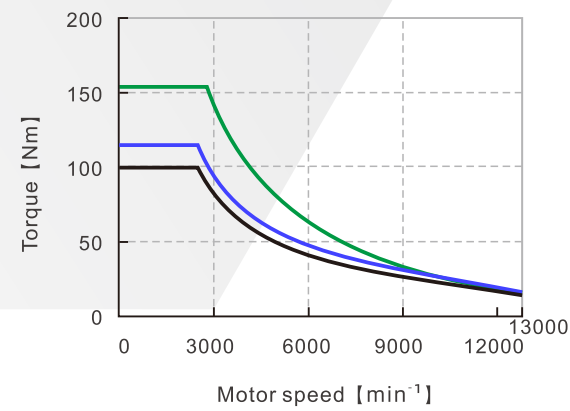
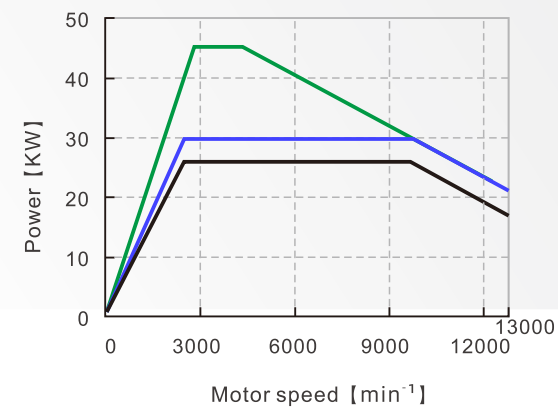

Motorized spindle power、torque diagram(12000rpm、22/37KW)

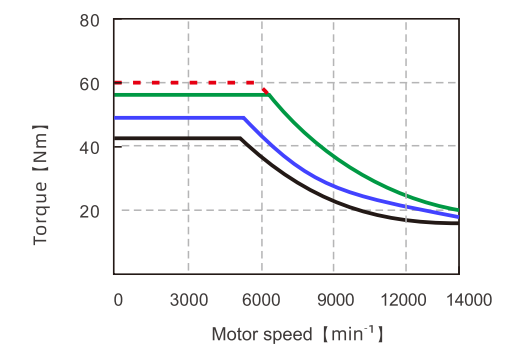
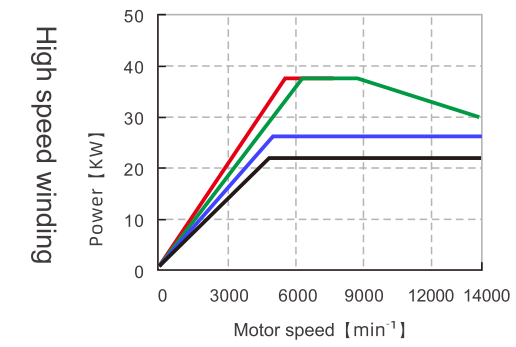
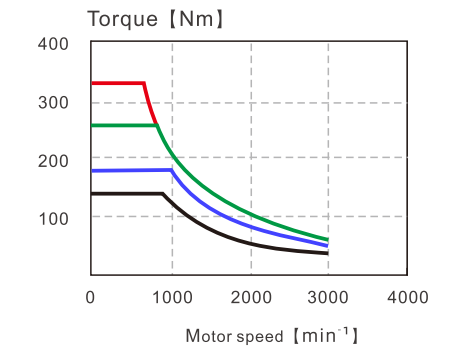

Motorized spindle power、torque diagram(15000 rpm、15/26KW)

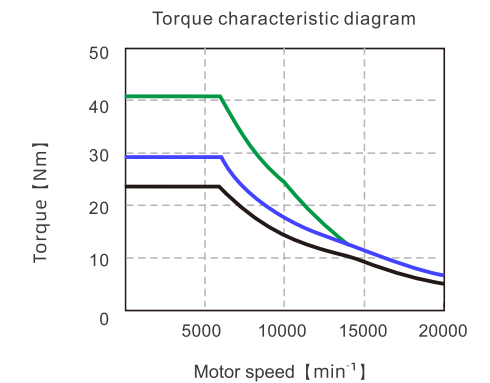
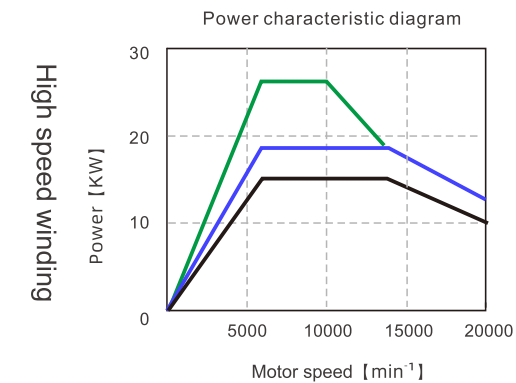
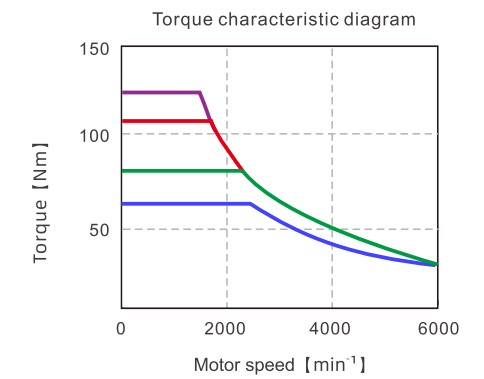
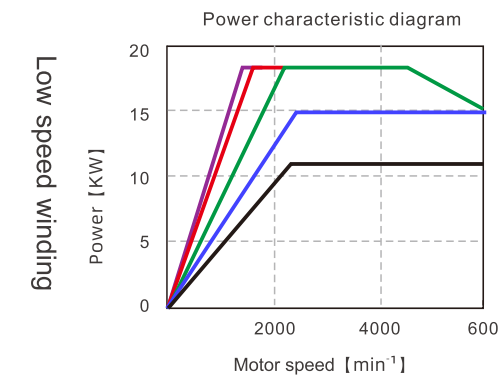



G-V、G-R series main parameter

Items		Unit	G-V(G-R)1520/1530/1540 A <sup>1</sup> /B <sup>2</sup> /C <sup>3</sup> /Z <sup>4</sup>	G-V(G-R)2030/2040/2050/2060 A/B/C/Z
Range of Processing	Worktable travel(X axis)	mm	2200/3200/4200	3200/4200/5200/6200
	Saddle travel(Y axis)	mm	A/B/C:2200; Z(Pentahedron):2700	A/B/C:2700; Z(Pentahedron):3200
	Ram travel(Z axis)	mm	Standard: 1000; Opt: 1250	Standard: 1000; Opt: 1250
	Distance from spindle end to work table	mm	250-1250; Opt 250-1500	250-1250; Opt 250-1500
	Distance between column	mm	1950	2450
Worktable	Worktable width	mm	1500	2000
	Worktable length	mm	2000/3000/4000	3000/4000/5000/6000
	Load capacity	T	6/10/13	15/19/22/25
	Width of T-slot	mm	28	28
Spindle	Spindle taper hole	/	A/B/Z:BT50; C:Standard BBT40, Opt HSK-100A、BT50	A/B/Z:BT50; C:Standard BT50, Opt HSK-100A、BBT40
	Spindle motor power (rated / maximum)	kw	A,B:15/18.5; C:Standard 15/26, Opt 22/37、15/26; Z:15/25	A,B,Z:22/35; C:Standard 26/45, Opt 22/37、15/26
	Speed range	r/min	A: Standard 6000,Opt 4000; B/Z:6000;(G-R series: Zaxis Standard 5000, Opt 4000); C: Standard 100-15000, Opt 100-12000, 80-10000	A:Standard 6000,Opt 4000; B/Z:6000;(G-R series: Zaxis Standard 5000, Opt 4000); C: Standard 80-10000, Opt 100-12000, 100-15000
	Output torque (rated / maximum)	N.m	A: Standard 190/314; Opt 286/472; B: 807/1331; C: Standard 45.7/125; Opt 159/326; 305/623; Z: 539/897	A: Standard 186/297, Opt 280/446; B/Z:6000; (G-R series: Zaxis Standard 5000, Opt 4000); C: Standard 305/623, Opt: 159/326; 45.7/125
Guide rail	Ram section	mm	420×420(G-Rseries Zaxis Standard 400×400,Opt 450×450)	420×420(G-R series Zaxis Standard 400×400,Opt 450×450)
Tool	X axis/Y axis /Z axis		2-45Roller/2-55Roller/G-Vseries: 2-55Roller+2-45Roller G-R series: fully enclosed sliding	2-55Roller/2-55Roller/G-V series: 2-55Roller+2-45Roller G-R series: fully enclosed sliding
	Motor power	kw	3/3/3	6/4/7; X axis travel≥ 5200h 9/4/7
	Tool magazine capacity		24(40)	24(40)
Speed	Maximum tool diameter	mm/mm/kg	Φ110/350/15	Φ110/350/15
	Maximum tool diameter	mm	Φ200	Φ200
	Speed of cutting feed	m/min	10/10/10; X axis travel≥ 4200h 8/8/8	10/10/10; X axis travel≥ 4200h 8/8/8; X axis travel 6200h 6/6/6
Precision of Machine Tool	Rapid Speed of X/Y/Z axis	m/min	15/15/15; X axis travel≥ 4200h 10/15/15	15/15/15; X axis travel≥ 4200h 10/15/15
	Positioning accuracy (X/Y/Z). (full itinerary)	No-raster	0.026(0.030,0.036)/0.026(Z:0.027)/0.02	0.030(0.036,0.040,0.045)/0.027/0.02
		Raster	0.021(0.025,0.031)/0.021(Z:0.023)/0.16	0.025(0.031,0.036,0.041)/0.023/0.016
	Repetitive positioning accuracy (X/Y/Z). (full itinerary)	No-raster	0.016(0.019,0.022)/0.016/0.013	0.019(0.022,0.025,0.028)/0.016/0.013
Raster		0.014(0.017,0.020)/0.014/0.012	0.017(0.020,0.023,0.025)/0.014/0.012	
Others	Z axis counter weight		Nitrogen balance	Nitrogen balance
	CNC System		A,B,C: FANUC 0i-MF(5)/β motor, Opt FANUC 0i-MF(1)/a motor; Z: FANUC 0i-MF(1)/a motor	FANUC 0i-MF(1)/a motor
	Total weight of machine tool	KVA	50	60
	Machine size (length*width*height)	mm	A,B,C: 6406(7676,10241)*5576*5200(5900) Z: 7676(10239)*6134*5200(Z axis Opt 5900)	7766(10238,12384,14650)*6134(Z:6634)*5200 (Z axis Opt 5900)
	Mainframe weight(About)	T	21/24/27(Z series adds 1.5 tons)	29/33.5/38/42.5(Z series adds 1.5 tons)

Note:

1. A means belt type spindle (G-R model does not have this configuration);
2. B means full gear drive spindle head;
3. C means electric spindle
4. Z means full gear drive spindle head (G-V1520 model does not have this configuration), standard automatic right-angle head, pentahedrondouble column.

- Optional specifications:
1. Workbench width is 1800;
  2. Door width 2500
  3. Y-axis stroke 2700.

- Optional specifications:
1. Workbench width is 2300;
  2. Door width 3000.
  3. Y-axis stroke 3200.

G-V、G-R Gantry Machining Centerseries parameters Main Parameter

Items		Unit	G-V(G-R)2530/2540/2550/2560 A/B/C/Z	G-V(G-R)3040/3050/3060 A/B/C/Z
Range of Processing	Worktable travel(X axis)	mm	3200/4200/5200/6200	4200/5200/6200
	Saddle travel(Y axis)	mm	A/B/C:3200; Z(Pentahedron):3700	A/B/C:3700; Z(Pentahedron):4200
	Ram travel(Z axis)	mm	Standard: 1000; Opt: 1250	Standard: 1000; Opt: 1250
	Distance from spindle end to work table	mm	250-1250; Opt 250-1500	250-1250; Opt 250-1500
	Distance between column	mm	2950	3450
Worktable	Worktable width	mm	2500	3000
	Worktable length	mm	3000/4000/5000/6000	4000/5000/6000
	Load capacity	T	18/22/25/28	24/28/32
	Width of T-slot	mm	28	28
Spindle	Spindle taper hole	/	A/B/Z: BT50; C: Standard BT50, Opt HSK-100A、BBT40	A/B/Z: BT50; C: Standard BT50, Opt HSK-100A、BBT40
	Spindle motor power (rated / maximum)	kw	A,B,Z: 22/35; C: Standard 26/45, Opt 22/37、15/26	A,B,Z:22/35; C:Standard 26/45, Opt 22/37、15/26
	Speed range	r/min	A:Standard 6000, Opt 4000; B/Z:6000;(G-R series: Zaxis Standard 5000, Opt 4000); C: Standard 80-10000, Opt 100-12000, 100-15000	A:Standard 6000, Opt 4000; B/Z:6000;(G-R series: Zaxis Standard 5000, Opt 4000); C: Standard 80-10000, Opt 100-12000, 100-15000
	Output torque (rated / maximum)	N.m	A:Standard 186/297, Opt 280/446; B,Z: 790/1258; C:Standard 305/623; Opt 159/326; 45.7/125	A:Standard 186/297, Opt 280/446; B,Z: 790/1258; C:Standard 305/623; Opt 159/326; 45.7/125
Guide rail	Ram section	mm	420×420(G-R series Zaxis Opt 400×400, Opt 450×450)	420×420(G-R series Zaxis Opt 400×400, Opt 450×450)
Tool	X axis/Y axis /Z axis		2-55Roller/2-55Roller/G-Vseries: 2-55Roller+2-45Roller G-Rseries: fully enclosed sliding	4-45Roller/2-55Roller/G-Vseries: 2-55Roller+2-45Roller G-Rseries: fully enclosed sliding
	Motor power	kw	6/4/7; X axis travel≥ 5200h 9/4/7	6/4/7; X axis travel≥ 5200h 9/4/7
	Tool magazine capacity		24(40)	24(40)
Speed	Maximum tool diameter	mm/mm/kg	Φ110/350/15	Φ110/350/15
	Maximum tool diameter	mm	Φ200	Φ200
	Speed of cutting feed	m/min	10/10/10, X axis travel 4200/5200h 8/8/8, X axis travel 6200h 6/6/6	8/8/8, X axis travel≥ 5200h 6/6/6
Precision of Machine Tool	Rapid speed of X/Y/Z axis	m/min	A,B,C:15/15/15, X axis travel≥ 4200h 10/15/15; Z:15/15/15, X axis travel≥ 4200h 10/15/15	A,B,C:10/12/15; Z:10/10/15
	Positioning accuracy (X/Y/Z). (full itinerary)	No-raster	0.030(0.036,0.040,0.045)/0.030(Z:0.032)/0.020	0.036(0.040,0.045)/0.032(Z:0.036)/0.020
		Raster	0.025(0.031,0.036,0.041)/0.025(Z:0.028)/0.016	0.031(0.036,0.041)/0.028(Z:0.031)/0.016
	Repetitive positioning accuracy (X/Y/Z). (full itinerary)	No-raster	0.019(0.022,0.025,0.028)/0.019/0.013	0.022(0.025,0.028)/0.019(Z:0.022)/0.013
Raster		0.017(0.020,0.023,0.025)/0.017/0.012	0.020(0.023,0.025)/0.017(Z:0.020)/0.012	
Others	Z axis counter weight		Nitrogen balance	Nitrogen balance
	CNC system		FANUC 0i-MF(1)/a motor	FANUC 0i-MF(1)/a motor
	Total weight of machine tool	KVA	65	70
	Machine size (length*width*height)	mm	8015(10020,12164,14645)*6634(Z:7281)*5200 (Zaxis Opt 5900)	10238(12348,14650)*6674(Z:7771)*5200 (Zaxis Opt 5900)
	Mainframe weight(About)	T	31.5/36.5/41.5/46.5(Z series adds 1.5 tons)	42/47.5/53(Z series adds 2 tons)

Note:

1. A means belt type spindle (G-R model does not have this configuration);
2. B means full gear drive spindle head;
3. C means electric spindle
4. Z means full gear drive spindle head, standard automatic right-angle head, pentahedrondouble column.

- Optional specifications:
1. Workbench width is 2800.
  2. Door width 3500
  3. Y-axis stroke 3700.

- Optional specifications:
1. Workbench width is 3300.
  2. Door width 4000.
  3. Y-axis stroke 4200.



Bridge type double column machining center

# G-B BRIDGE TYPE DOUBLE COLUMN MACHINING CENTER



## ADVANTAGE

G-B bridge type gantry machining center series machine tools are new products developed and designed by our company, which are widely used in the processing of parts in industries such as automobiles, energy, molds, and ships. The workbench is fixed, and the structure of the viaduct type gantry frame. The whole machine consists of worktable, bed, sliding seat, beam, saddle, ram, high-speed electric spindle, spindle constant temperature cooling system, coordinate axis grease automatic lubrication system, machine tool pneumatic system, machine tool hydraulic system, Z-axis balance system, automatic chip removal device on both sides of the table, the tool water cooling system, the large-capacity water tank, the full protection of the machine tool, the operation panel and electronic control system.

- ▶ X axis: The beam and carriage move longitudinally back and forth along the guide rail on the elevated bed;
- ▶ Y axis: The saddle moves left and right along the guide rail on the beam;
- ▶ Zaxis: The ram moves up and down along the guide rail on the saddle.

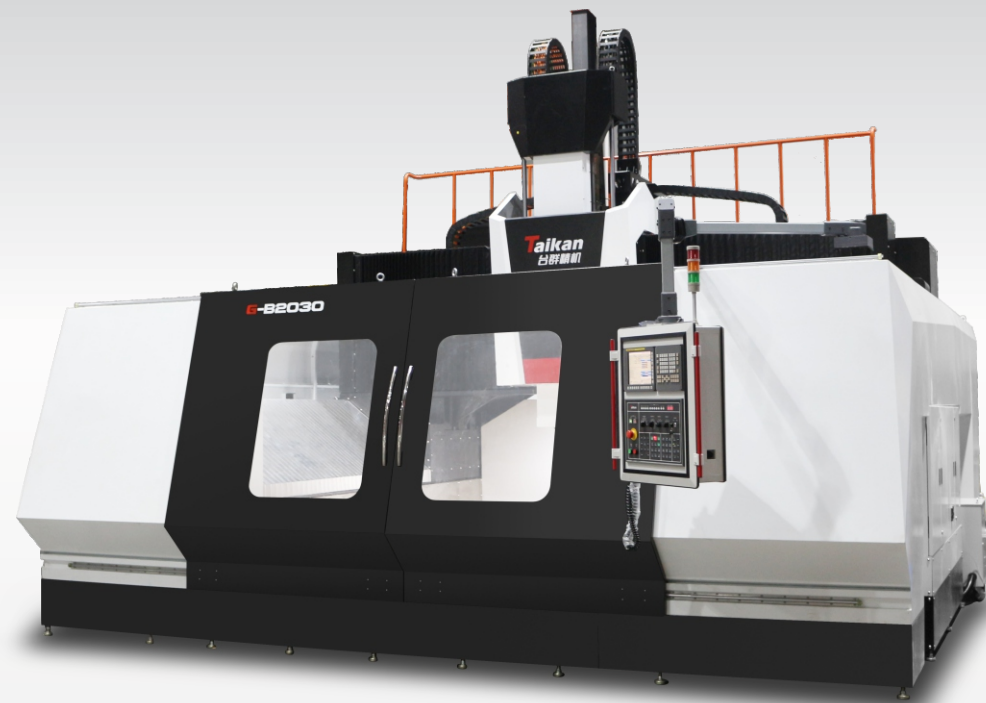

### G-B series machine model description

Model	G	-	B	**	**
Des	Double column machining center	-	Bridge	Width of worktable 1/100	Length of worktable 1/100

## Bed structure

The bed and sliding seat are made of high-strength high-quality cast iron with strong rigidity and good shock absorption performance.

The bed guide rail adopts high-precision roller linear guide, the transmission system adopts double column axis double motors, and the high-precision ball screw is directly driven by a low backlash reducer, and the double column axis synchronization control function of the CNC system ensures the high dynamics feed rate of the moving parts.

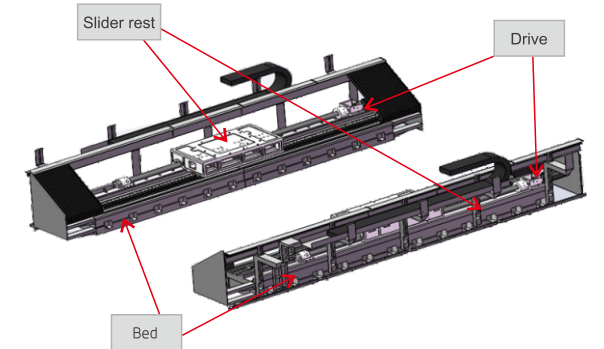

## Beam structure

The large beams are made of high-strength, high-quality cast iron, which has strong rigidity and good shock absorption performance; large cross-section, strong rigidity, low inertia, and good high-speed performance.

The beam guide adopts a high-precision roller linear guide ladder arrangement, which has a large span, strong rigidity and good seismic performance. The transmission system adopts servo motor, and the ball screw pair is directly driven by low backlash reducer, so as to realize high dynamic feed of Y axis.

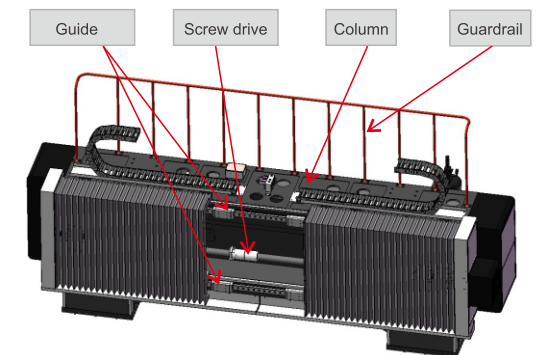

## Saddle and ram

The saddle and square ram are made of high-strength, high-quality cast iron, which has strong rigidity and good shock absorption performance; large cross-section and strong rigidity.

The ram cuts 420x420mm, adopts 4 high-precision linear roller guides, symmetrically arranged on both sides, and is supported by eight sliding blocks to restrain the Z-direction guide. The spindle has strong overhang rigidity and good high-speed performance. The transmission system is driven by servo motor, and the ball screw pair is directly driven by low backlash reducer, so as to realize the Y-axis high dynamic feed and directly drive the ball screw pair. The two cylinder balance system is supplemented on both sides of the ram to ensure stable Z-direction feed commutation and dynamic response speed.

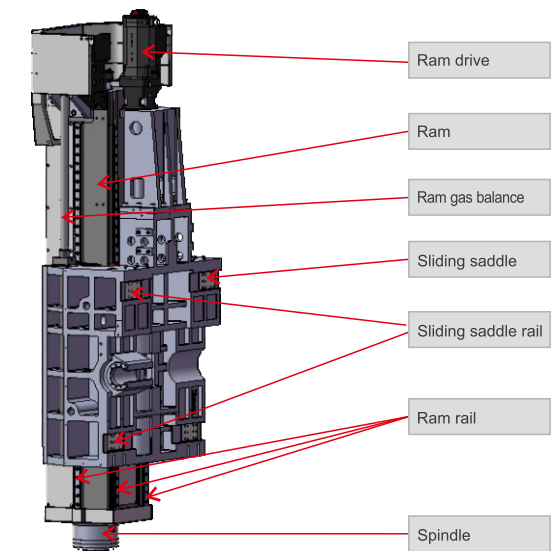

### Spindle introduction

The motorized spindle for this machine tool has the same specifications as the motorized spindle for the GV series double column machining center. It is equipped with BT50 high-speed electric spindle as standard, with a maximum speed of 10000rpm, a rated torque of 305 Nm, and a short-time up to 623 Nm; two other motorized spindles of 12000rpm and 18000rpm are optional. The spindle has stable and reliable performance and can meet different processing needs.

### Pneumatic and lubrication system introduction

The main pneumatic components of this machine tool are Japanese SMC products, with reliable performance, simple installation, adjustment and operation;  
The coordinate axis grease lubrication system adopts a progressive two-stage distributor, and the numerical control system automatically controls, regularly and quantitatively delivers lubricant to each transmission element. The amount of oil supplied by the distributor is adjustable, and there is an alarm when the oil circuit is blocked;  
Grease lubrication does not have the problem of oil leakage. Grease lubrication is easy to store. The time interval for grease supply is 6-8 hours. The amount of use is small, the user's use cost is low, and it is environmentally friendly.

### Hydraulic and cooling system

The machine tool spindle is separately equipped with a hydraulic pump station to ensure that the spindle is loose and the clamping action is safe and reliable; the Z axis adopts a nitrogen balance system; the machine tool motorized spindle is equipped with a constant temperature cooling system, which has good cooling effect and accurate spindle temperature control.

### G-B bridge type main parameter

Items		Unit	G-B20∞	G-B25∞	G-B30∞
Range of Processing	Worktable travel(X axis)	mm	2200~∞		
	Saddle stroke (Y axis)	mm	2200	2700	3800
	Ram travel(Z axis)	mm	1000		
	Distance from spindle end to worktable	mm	100~1100		
	Effective door width	mm	2800	3300	3800
Worktable	Size of worktable	mm	2000 × (2000~∞)	2500 × (2000~∞)	3000 × (2000~∞)
	Load capacity	kg/m <sup>2</sup>	5000		
	Width of T-slot	mm	28		
Spindle	Motor power of spindle	kw	standard26/45; opt22/37; 15/26		
	Range of speed	r/min	standard80~10000 (BT50),opt100~12000(HSK100A)、100~18000(HSK63A)		
	Output torque	Nm	standard305/623, opt159/326, opt45.7/125		
	Ram section	mm	420*420		
Speed	Speed of cutting feed	mm/min	10000/10000/10000		
	Rapid speed of X/Y/Z axis	mm/min	30000/30000/24000		
Others	CNC system		FANUC 0i-MF(I)		
	Z axis counter weight		2-Oil pressure + nitrogen balance		

### Bridge five-axis double column machining center

## G-BU BRIDGE FIVE-AXIS DOUBLE COLUMN MACHINING CENTER High-speed High-precision



### ADVANTAGE

The newly developed G-BU bridge type five-axis double column machining center machine tool can be widely used in the processing of parts in industries such as automobiles, energy, molds, ships, etc. It is aimed at processing small and medium-sized complex parts of ferrous and non-ferrous metals. And five-axis linkage processing, incorporating the high dynamic performance processing concept, so that it has the characteristics of high speed and high precision required for processing complex space surfaces. The worktable of this model is larger than 4 meters along the X axis. The Y-axis travel is greater than 3.2 meters.



### G-BU series machine model description

Model	G	-	B	U	**	**
Des	Double column machine	-	Bridge	Five-axis	Width of worktable1/100	Length of worktable1/100

### Five-axis milling head spindle parameters

Para	Standard	Optional	Optional
Spindle power(KW)	43/52	56/70	45
Max speed(rpm)	24000	18000	15000
Output torque(Nm)	67/83	90/111	120/145
Type of tool holder	HSK63A	HSK63A	HSK100A
Bearing lubrication	oil	oil	oil



Standard five-axis swing head spindle power torque diagram (24000rpm, 43/52KW)

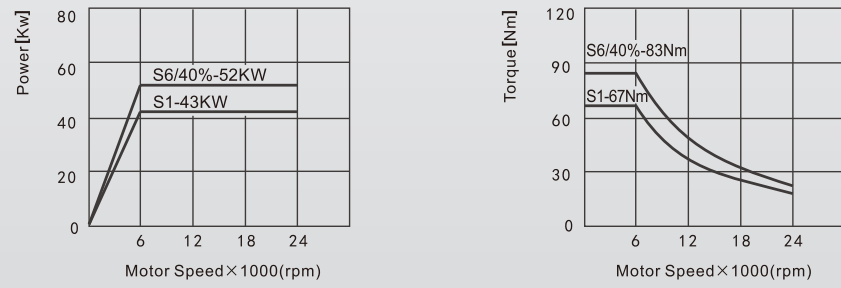

Standard five-axis swing head spindle power torque diagram (18000rpm, 56/70KW)

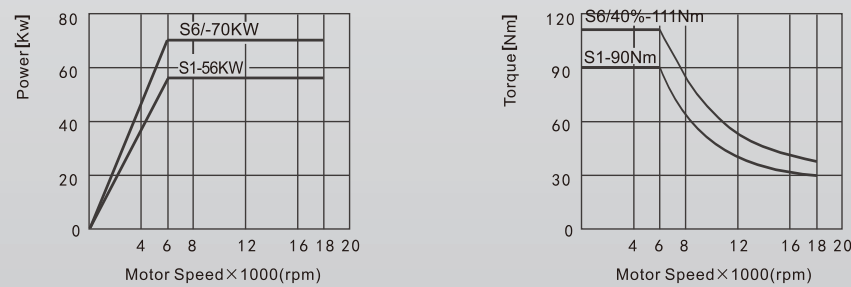

Standard five-axis swing head spindle power torque diagram (15000rpm, 45KW)

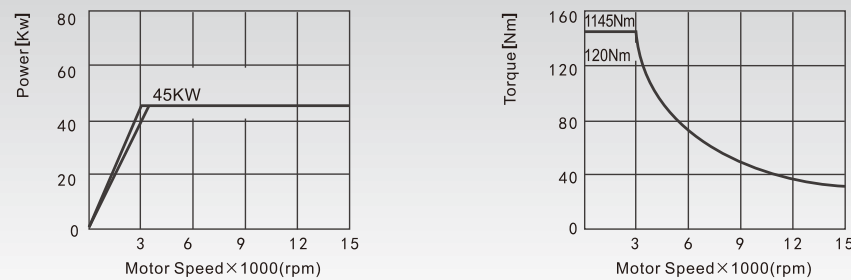

Processing Capacity-Heavy Cutting Data

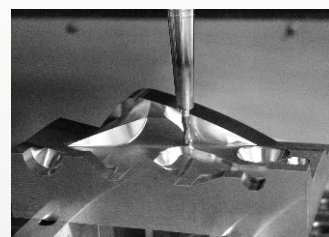

Comprehensive surface processing

Tools	D8R4 ball cutter
Processing material	S136
Spindle speed	7000rpm
Feed rate	2100mm/min
Cutting depth	0.05mm
Step length	0.1mm

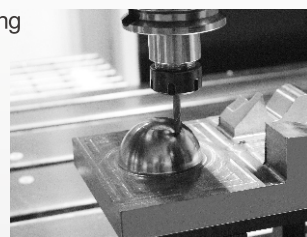

Comprehensive surface processing

D16 Tungsten Steel End Mill	D10R5 ball cutter
Processing material	S136
Spindle speed	3500rpm
Feed rate	1600mm/min
Cutting depth	0.1mm
Step length	0.2mm

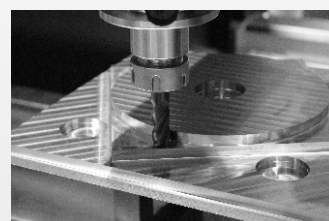

International standard workpiece processing

D16 Tungsten Steel End Mill	φ16
Processing material	S136
Spindle speed	3500rpm
Feed rate	800mm/min
Cutting depth	0.1mm

G-BU bridge type gantry machine parameters

Items	Unit	G-BU25∞	G-BU30∞	
Range of Processing	Worktable Travel(X axis)	mm	2200~∞	
	(Y axis)Wagen Travel(Y axis)	mm	2700	3800
	Ram Travel(Z axis)	mm	1000	
	Distance From Spindle End to Worktable	mm	100~1100	
	Distance between column	mm	3300	3800
Worktable	Size of Worktable	mm	2500 × (4000~∞)	3000 × (4000~∞)
	Load capacity	kg/m <sup>2</sup>	5000	
	Width of T-slot	mm	28	
Spindle	Motor Power of Spindle	kw	standard43/52, opt56/70、45	
	Range of Speed	r/min	standard100~2400(HSK63A), opt100~18000(HSK63A)、100~15000 (HSK100A)	
	Output Torque	Nm	standard76/83; opt90/111;120/145	
	Ram Section	mm	420*420	
Speed	Speed of Cutting Feed	mm/min	20000/20000/20000	
	Rapid Speed of X/Y/Z axis	mm/min	30000/30000/24000	
Others	CNC System		SIEMENS840DSL	
	Z axis counter Weight		2-Oil pressure + nitrogen balance	

All pictures in this catalog are for reference only, subject to the actual machine; the company's products are continuously improved. If the above information is changed, we will not notify you. (Note: ∞represents any size)

G-B(U) Bridge type gantry milling machine demension

(Unit: mm)

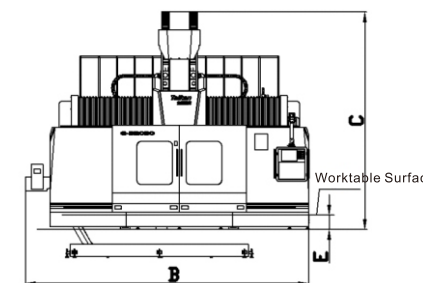
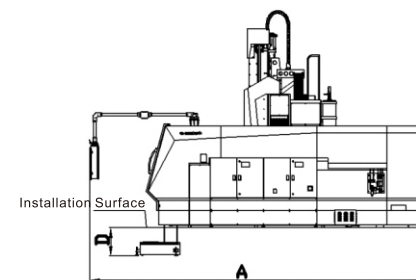

Machine model	A	B	C	D	E
G-B2020	5500				
G-B2030	6500	5800	5000	640	320
G-B20∞	∞				
G-B2540	7500				
G-B2550	8500	6400	5000		
G-B25∞	∞			640	320
G-BU2540	7500				
G-BU2550	8500	7400	5600		
G-BU25∞	∞				
G-B3040	7500				
G-B3050	8500	6900	5000		
G-B30∞	∞			640	320
G-BU3040	7500				
G-BU3050	8500	7900	5600		
G-BU30∞	∞				

All pictures in this catalog are for reference only, subject to the actual machine; the company's products are continuously improved. If the above information is changed, we will not notify you. (Note: ∞represents any size)

### Optional part



⊙ Right-angle milling head  
Speed/2000rpm/min,BT50  
◆ Exchange head by hand, Manual lock

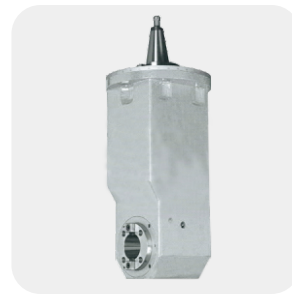

⊙ Right-angle narrow milling head  
Speed /800rpm/min, BT40  
◆ Exchange head by hand, Manual lock

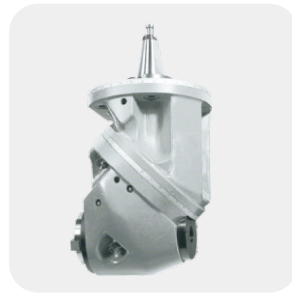

⊙ Universal milling head  
Speed /1200rpm/min, BT50  
◆ Exchange head by hand, Manual lock



⊙ Extended milling head  
Speed /2000rpm/min, BT50  
◆ Exchange head by hand, Manual lock



CNC rotary table



40T chain tool magazine

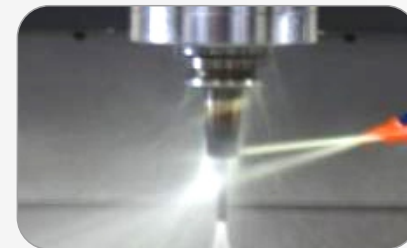

2MPa coolant through spindle



Grating scal



Disc Tool Magazine

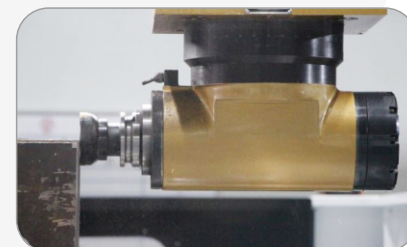

Automatic right-angle milling head

### Quality Assurance

Stick to the best quality and never compromise,check the inspection standard with the strictest quality.

- Precision testing of machining parts
- Deadly brand laser positioning test
- Main shaft and spindle power balance correction
- Measurement of roundness verticality of club instrument

